

INDICATORS • SPEAKERS • SOUND TRANSDUCERS • ENCLOSURES • MICROPHONES • BATTERY ACCESSORIES

CAB50A3-01T-2

Former P/N: BH-411-3P24

Rev. 2-2018
RoHS3 & REACH
Battery Assembly



Physical Characteristics

MATERIALS

Housing	Plastic, PP Resin, Black
Contact	65C Spring Wire

TEMPERATURE RANGES

Operating	-20 to +65 °C
Storage	-30 to +85 °C

Cell Type AAA, or equivalent

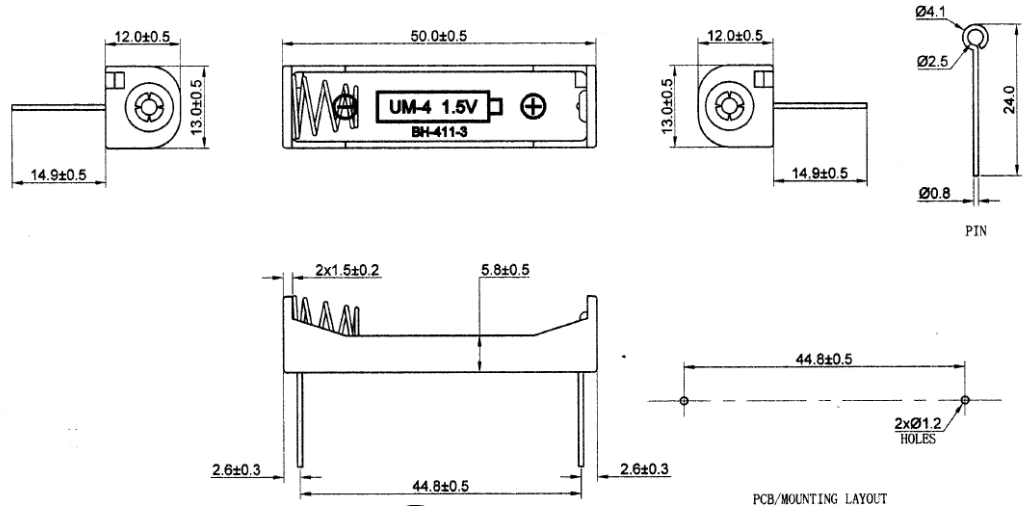

Revision	Description	By	Date
2-2018	Migrate to new format	WS	2018-02-22

Warranty: For a period of one (1) year from date of shipping under normal operations conditions This warranty does not apply to products damaged through misuse, abuse, improper installation, alteration, rework, or attempt to repair.

The information contained herein is believed to be correct, but no guarantee or warranty, express or implied, with respect to accuracy, completeness or results is extended and no liability is assumed. Challenge Electronics reserves the right to make changes in any specification, data or material contained herein.
©2019 Challenge Electronics, Inc. 20190826154149