



PRODUCT INFORMATION

Part #: **CE-CX330AVQ**

Revision: 3-2012



DESCRIPTION		FEATURES			
Challenge Electronics CONTINUOUS Tone, EXTRA Loud, 3 to 30 Vdc, A style case Rear Panel Mounting in 1.125" (28.6 mm) Hole, Sound Pressure Level of 103 dB(A) at 30 Vdc at 61 cm, 2,900 Hz. Output Frequency, Q Quick Disconnect Blades termination, Piezoelectric Alarm with a mechanical V olume Control, RoHS Compliant		<ul style="list-style-type: none"> ◆ Reliable Solid State Piezoelectric Technology ◆ Corrosion resistant Stainless Steel Diaphragm ◆ Flame Retardant Plastic ◆ Extended storage temperature ◆ Hermetically Sealed Alarm ◆ Water Proof, NEMA 3R, 4X, or 12 with Gasket (not supplied) ◆ RoHS, Lead Free Compliance ◆ ISO 9001 Certified 			
SPECIFICATIONS					
Operating Mode	Extra Loud, Continuous Tones		Pulse Rate		
Operating Voltage	3 to 30 Vdc		Nominal Operating Voltage		24 Vdc
Operating Frequency	2,900 ± 500 Hz.				
Typical Loudness	At Minimum Voltage	85 ± 5 dB(A), at 3 Vdc, 24 inches (61 cm), 25°C			
	At Maximum Voltage	103 ± 3 dB(A), at 30 Vdc, 24 inches (61 cm), 25°C			
Volume Control	Maximum Sound Pressure Level can be restricted up to 20 dB from maximum output. (Note, The Volume Control Rotor may reduce maximum loudness) To install, simply, push the ROTOR onto the front of alarm until it snapped in place To attenuate sound, while alarm is turned on, rotate the ROTOR until maximum desired sound is achieved				
Typical Operating Current	At Minimum Voltage	7 mA at 3 Vdc	At Maximum Voltage	50 mA at 30 Vdc	
Operating Temperature	-30°C to +65°C		Storage Temperature	-40°C to +105°C	
Surge Voltage	20% over maximum Operating Voltage for less than 5 minutes				
Materials	Alarm Case	Plastic, "A" Case, NORYL™, PX9406 or equal, flame retardant UL 94-V0, Black			
	Diaphragm	Stainless Steel 304			
	Encapsulation	Two parts epoxy resign or silicone potting, Black			
	Termination	Two (2), 0.25 (6.4 mm) Quick Connect Blades, 0.032Ø (0.8Ø mm) wide, Brass, Electro-Tin plated			
Physical Dimensions	Length or Diameter (L/D)	1.4" (35.6 mm) Ø	Width (W)	Height (H)	1.46" (37.1 mm)
Approximate Weight	37 grams	Removable Washing Label	No	Compliance	RoHS
Available Options					
RELIABILITY					
Thermal Operating Temperature Test	240 hours continuous operation at Rated Power, at Maximum Rated Operating Temperature *				
	240 hours continuous operation at Rated Power, at Minimum Rated Operating Temperature *				
Thermal Storage Temperature Test	96 hours storage at Maximum Rated Storage Temperatures *				
	96 hours storage at Minimum Rated Storage Temperatures *				
Thermal Shock Test	5 cycles of Minimum and Maximum Operating Temperature Each cycle shall be set per diagram below and is 3 hours long *				
Humidity Test	120 Hours at +60°C±2°C, 90-95% RH *				
Salt Spray	Withstand exposure to salt spray per ASTM B117 for a period of 300 hours *				
Water & Dust Exposure	Withstands water submergence and dust exposure per IP-68 *				
Vibration Test	2 Hours at 1.5 mm with 10 to 55 Hz. of vibration frequency to each of 3 perpendicular direction *				
Drop Test	Dropped naturally from 1 meter height onto the surface of 10mm wooden board, 2 directions upper and side of the part are applied *				
Termination Strength	Maximum of 15 pounds (6.8 Kg) load pull test				
* Reliability Test Performance	Parts should conform to original performance within ±3 dB, after 3 hours of recovery and dry period				
Life Test	Intermittent	1,000 hours of a 1 minute on 4 minutes off cycle at room temperature and Maximum Rated Voltage			
	Continuous	250 hours continuous operation at Maximum Rated Voltage and maximum Operating Temperatures			
Warranty	For a period of one (1) year from date of shipping under normal operations conditions This warranty does not apply to products damaged through misuse, abuse, improper installation, alteration, rework, or attempt to repair				

The information contained herein is believed to be correct, but no guarantee or warranty, express or implied, with respect to accuracy, completeness or results is extended and no liability is assumed.
Challenge Electronics reserves the right to make changes in any specification, data or material contained herein.

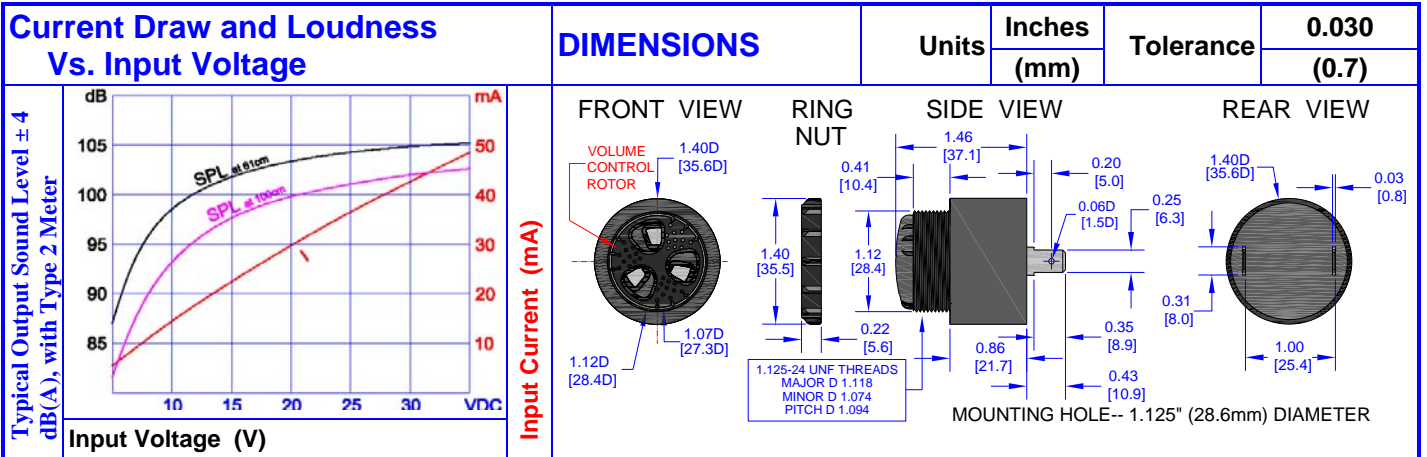

PACKAGING

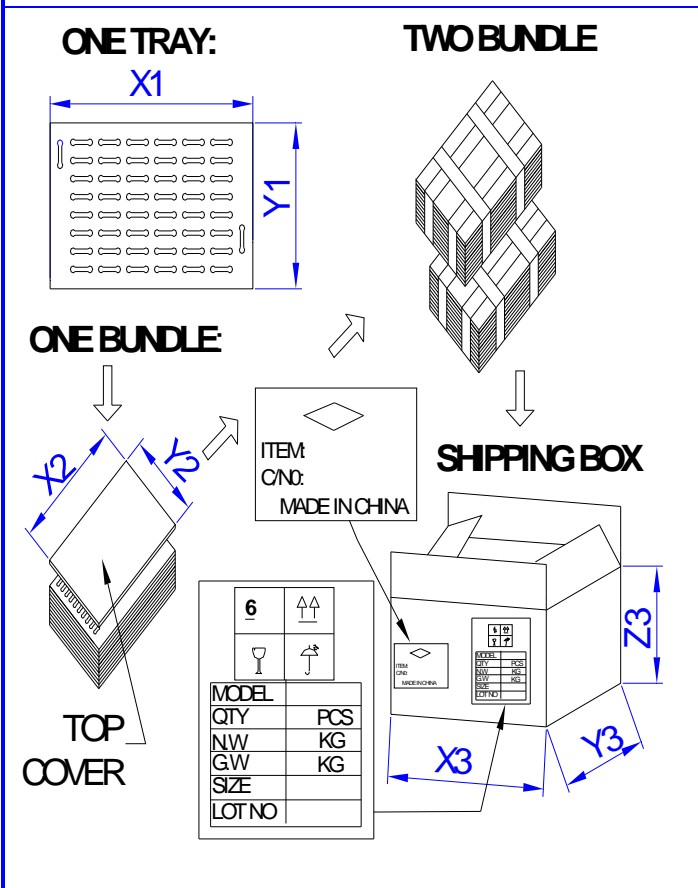

Tray		
Dimensions	X1	34.7 cm
	Y1	34.7 cm
	Z1	21.2 cm
Quantity	42	
SHIPPING BOX		
Dimensions	X2	35 cm
	Y2	35 cm
	Z2	22.5 cm
Part Number		
Customer PN (if required)		
Number of Trays		
Quantity	250	
Lot and/or Date Code		
PO Number		
Net Weight		
Gross Weight		
Box Number		
of Number of Boxes		
Country of Origin	Made in China	

The information contained herein is believed to be correct, but no guarantee or warranty, express or implied, with respect to accuracy, completeness or results is extended and no liability is assumed.
 Challenge Electronics reserves the right to make changes in any specification, data or material contained herein.