



PRODUCT INFORMATION

PART #	CEPX3500-270-03C30-500R	Revision: 0-2015
---------------	--------------------------------	-------------------------



Piezoelectric Ceramic Sound Element

DESCRIPTION

Challenge Electronics Piezoelectric X-tal Direct Drive 3500 Hz. (Fo) Resonant Frequency; 27 mm Diameter; 0.35 mm Thick; Ceramic Resonator; 30 V Max; 500 Ω Max at Resonance; RoHS, Lead Free and REACH Compliant

SPECIFICATIONS

Resonant Frequency (Fo)	3500 ± 500 Hz.	Maximum Operating Voltage	30 Vp-p	Maximum Resonant Impedance	500 Ohms	
Assembly Type	Direct Drive (2 Contacts)	Recommended Mounting	Edge Mount for Direct Drive			
Static Capacitance	26,000 ± 30% pF at 100 Hz.	Operating Temperature	-20°C to +70°C	Storage Temperature	-30°C to +80°C	
Material	Ceramic	Piezoelectric Ceramic Disc, Silver Coated	Diaphragm	Stainless Steel Disc		
Termination	No					
Physical Dimensions	Diaphragm Diameter	27 ± 0.1 mm Ø	Ceramic Diameter	20 ± 0.1 mm Ø	Assembly Thickness	0.35 ± 0.03 mm
Options						
Approximate Weight	1.3 grams	Compliance	RoHS, Lead Free and REACH			

Caution

- Do not maintain Vdc (Direct Current) on the Piezoelectric Assembly. Constant Voltage may depolarize the Piezoelectric Ceramic Disc
- Handle with care, Piezoelectric Disc is made of Ceramic material. Any distortion or bending of the part will crack and cause catastrophic damage the Piezoelectric Disc

Warranty For a period of one (1) year from date of shipping with careful handling and under normal operations conditions
This warranty does not apply to products damaged through misuse, abuse, improper installation, alteration, rework, or attempt to repair

DIMENSIONS

Units in: mm, Tolerance: as specified

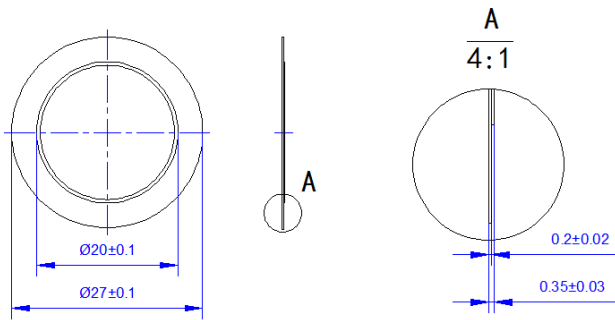

DRIVING CIRCUIT APPLICATIONS

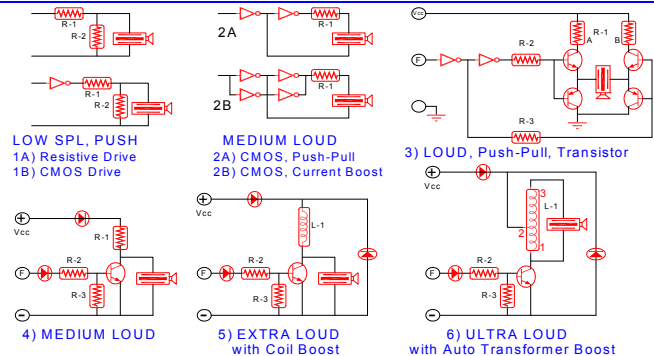

SUBSTANCE OF VERY HIGH CONCERN (REACH) and RoHS LEAD FREE COMPLIANCE

This product does NOT contain any of the REACH Substances of Very High Concern (SVHC), and is in compliance with European Union REACH Regulation No.1907/2006 regarding chemical substances which must be registered or disclosed

European Union Directive 2011/65/EU (RoHS Directive) of the European Parliament. And of the Council of 8 June 2011 and all subsequent amendments, The ANNEX III of the Directive Applications exempted from the restriction in Article 4(1): 7(c)-I, Electrical and electronic components containing lead in a glass or ceramic other than dielectric ceramic in capacitors, e.g. Piezoelectric devices, or in a glass or ceramic matrix compound Piezoelectric is also known as Lead Zirconate Titanate (PZT) ceramics. Piezoelectric Ceramic disc, (PZT), lead as high covalent compound in the ceramic matrix to achieve good ferroelectric properties in a wide temperature range. The best-known performances can be reached with PZT ceramics, which are a mixture of PbTiO3 and PbZrO3. The lead content, homogeneous material compound is between 58% and 68% by weight depending on the proportion of zirconium (Zr) and titanium (Ti)

PACKAGING

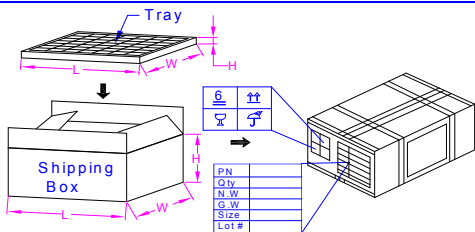

Shipping Box MARKING		SHIPPING BOX	
Part Number	Dimensions	L	cm
Lot and/or Date Code		W	cm
Quantity		H	cm
PO Number	Number of Trays		
Net Weight	Quantity		
Gross Weight	Approximate Weight		Kg.
Made in China			

Revision	Description	By	Date