

## CI40M-28T40-C-1

Former P/N: CEMB400Y195-228C400TR

Rev. 3-2019  
RoHS3 & REACH  
Mechanical Indicators



### Operating Characteristics

#### ELECTRICAL

Rated Voltage	24 VDC
Operating Voltage	20 to 28 VDC
Max Current at Vmax	55 mA

#### ACOUSTIC

Tone Category	Continuous
Description	Steady
Center $f$	400 $\pm$ 100 Hz
Min SPL at Vrated	95 dB
Test Conditions	10 cm

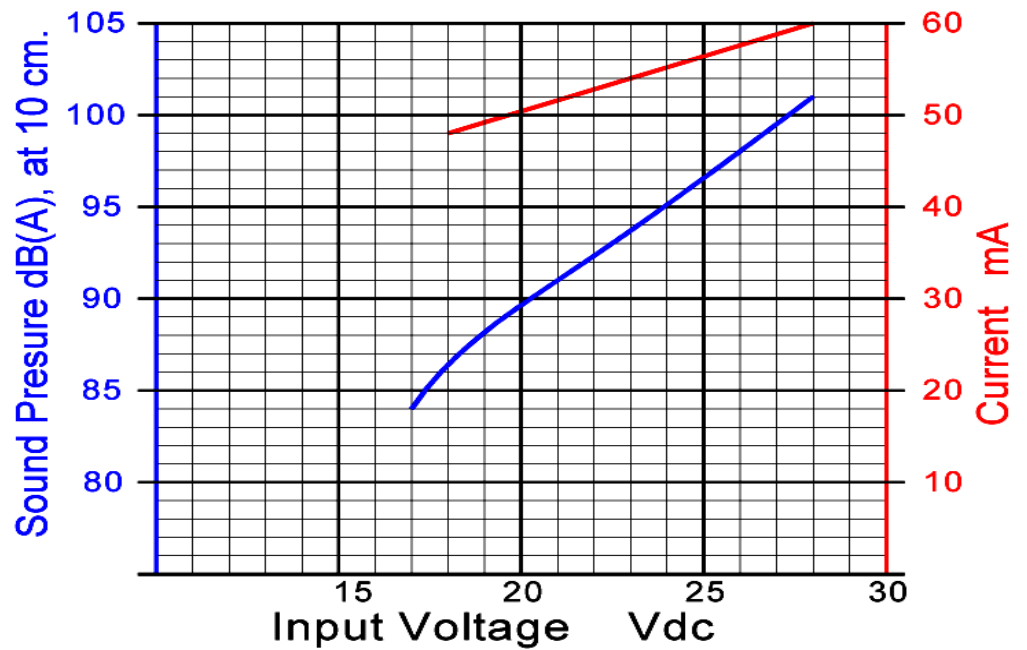

### Physical Characteristics

#### MATERIALS

Housing	Noryl
Diaphragm	Stainless Steel
PC Pin	Brass

#### TEMPERATURE RANGES

Operating	-30 to +70 °C
Storage	-40 to +85 °C

Weight 10 g

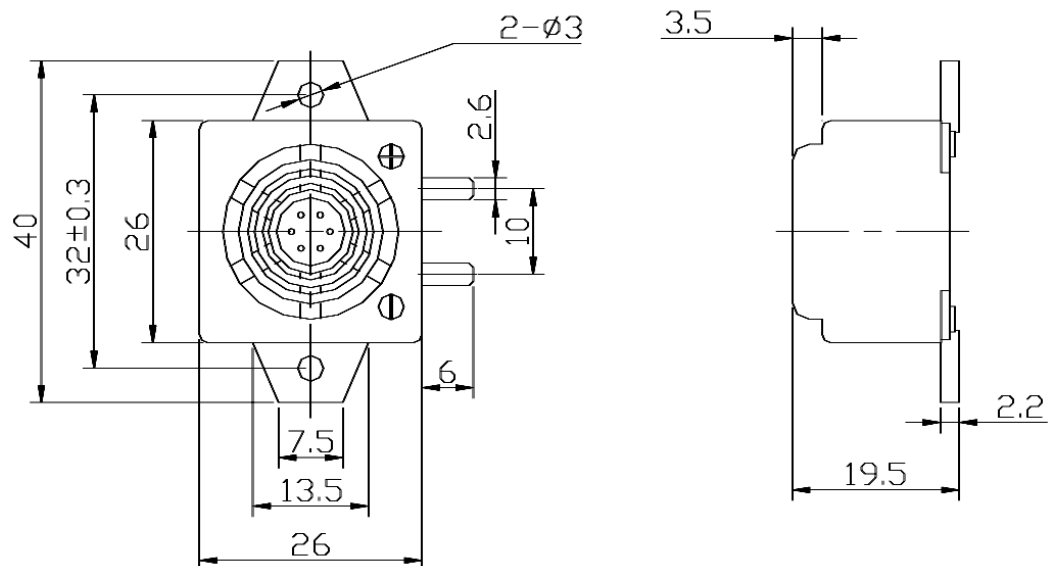

Revision	Description	By	Date
3-2019	Migrate to new format	YK	2019-06-21

Warranty: For a period of one (1) year from date of shipping under normal operations conditions This warranty does not apply to products damaged through misuse, abuse, improper installation, alteration, rework, or attempt to repair.

The information contained herein is believed to be correct, but no guarantee or warranty, express or implied, with respect to accuracy, completeness or results is extended and no liability is assumed. Challenge Electronics reserves the right to make changes in any specification, data or material contained herein.  
©2019 Challenge Electronics, Inc. 20190826153634