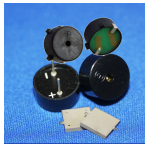

## CT22P-25T400-2

Former P/N: CT22PT-25400-2

 Rev. 1-2019  
 RoHS3 & REACH  
 Piezoelectric Sound Transducers

### Operating Characteristics

#### ELECTRICAL

Rated Voltage	3 Vp-p
Max Operating Voltage	25 Vp-p
Max Current at V Rated	3 mA
Capacitance	15000 pF ± 30 % 100 Hz

#### ACOUSTIC

Min SPL at V Rated	85 dB
Test Conditions	10 cm
$f_o$	4000 ± 500 Hz

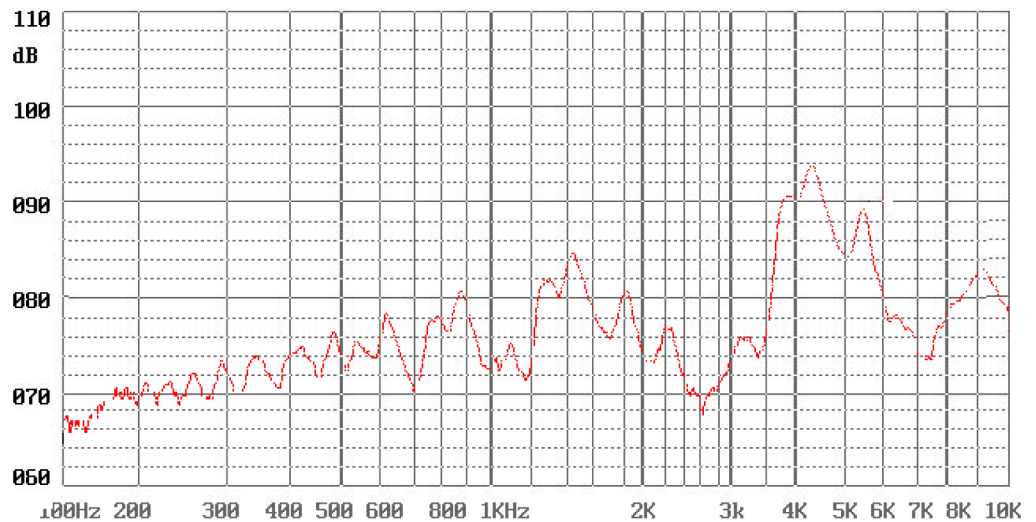

### Physical Characteristics

#### MATERIALS

Housing	PBT
Diaphragm	Brass
PC Pin	Brass

#### TEMPERATURE RANGES

Operating	-20 to +70 °C
Storage	-30 to +80 °C

Weight	2.6 g
--------	-------

### DIMENSIONS (UNIT: mm) Tolerance: ±0.5mm Except Specified

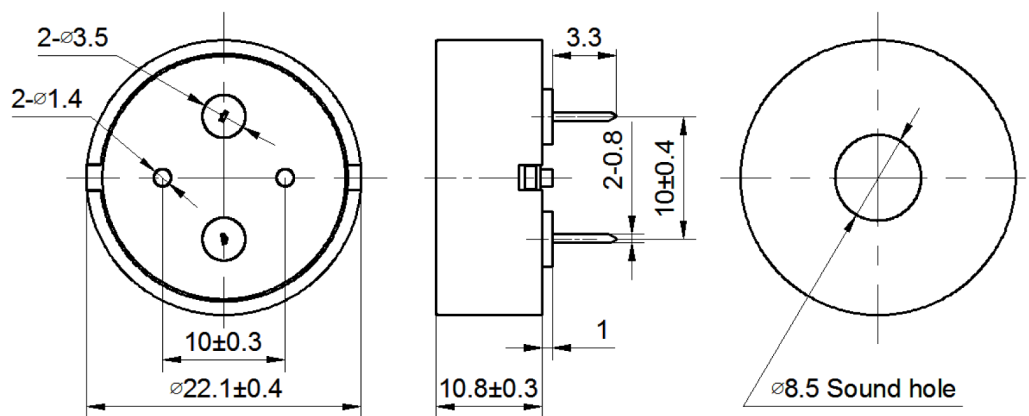

Revision	Description	By	Date
0-2019	Initial Specification Sheet	JL	2019-02-25
1-2019	Migrate to new format.	CF	2019-06-24

Warranty: For a period of one (1) year from date of shipping under normal operations conditions This warranty does not apply to products damaged through misuse, abuse, improper installation, alteration, rework, or attempt to repair.

The information contained herein is believed to be correct, but no guarantee or warranty, express or implied, with respect to accuracy, completeness or results is extended and no liability is assumed. Challenge Electronics reserves the right to make changes in any specification, data or material contained herein.